

## MECHANIC GUIDE

### INDUSTRIAL WATER SOFTENER EQUIPMENTS

Parallel connected volume-controlled two and three columned water softener equipments

Volume-controlled two columned	Volume-controlled three columned
BlueSoft-40D1/65	BlueSoft-180T1/63
BlueSoft-60D1/65	BlueSoft-240T1/63
BlueSoft-120D1/65	BlueSoft-320T1/63
BlueSoft-180D1/63	BlueSoft-400T1/63
BlueSoft-240D1/63	BlueSoft-400T1/92
BlueSoft-320D1/63	BlueSoft-500T1/63
BlueSoft-400D1/63	BlueSoft-500T1/92
BlueSoft-400D1/92	BlueSoft-500T1/74
BlueSoft-500D1/63	BlueSoft-600T1/74
BlueSoft-500D1/92	BlueSoft-800T1/74
BlueSoft-500D1/74	BlueSoft-1200T1/74
BlueSoft-600D1/74	BlueSoft-1200T1/99
BlueSoft-800D1/74	BlueSoft-1600T1/99
BlueSoft-1200D1/74	BlueSoft-1800T1/99
BlueSoft-1200D1/99	BlueSoft-2000T1/99
BlueSoft-1600D1/99	BlueSoft-2400T1/99
BlueSoft-1800D1/99	BlueSoft-2800T1/99
BlueSoft-2000D1/99	BlueSoft-2800T1/112
BlueSoft-2400D1/99	BlueSoft-3200T1/112
BlueSoft-2800D1/99	BlueSoft-3600T1/112
BlueSoft-2800D1/112	BlueSoft-4000T1/112
BlueSoft-3200D1/112	BlueSoft-4400T1/112
BlueSoft-3600D1/112	BlueSoft-4800T1/112
BlueSoft-4000D1/112	BlueSoft-5600T1/112
BlueSoft-4400D1/112	BlueSoft-5600T1/96
BlueSoft-4800D1/112	BlueSoft-6400T1/96
BlueSoft-5600D1/112	BlueSoft-7200T1/96
BlueSoft-5600D1/96	BlueSoft-8000T1/96
BlueSoft-6400D1/96	
BlueSoft-7200D1/96	
BlueSoft-8000D1/96	

# Euro-Clear Ltd.

Water purification and treatment equipment manufacturer and wholesale distributor

Tel: +36 96 544-240 • E-mail: [contact@euro-clear.eu](mailto:contact@euro-clear.eu) • Web: [www.euro-clear.eu](http://www.euro-clear.eu)

**Before using the equipment, read the guide carefully!**

## TABLE OF CONTENTS

1. Definition and function
2. Technical parameters
3. Main parts
4. The way it works
5. Installation and startup
6. Instruction about handling
7. Process of measuring the water hardness
8. Warranty, guarantee
9. Data sheet for setting up
10. Warranty document
11. Quality Certificate

# Euro-Clear Ltd.

Water purification and treatment equipment manufacturer and wholesale distributor  
Tel: +36 96 544-240 • E-mail: [contact@euro-clear.eu](mailto:contact@euro-clear.eu) • Web: [www.euro-clear.eu](http://www.euro-clear.eu)

## 1. DEFINITION AND FUNCTION

The equipment is an automatically operated and regenerated water softening device filled with cation exchanging strongly acid resin regenerated in Na form.

- 1.1. Water has got its natural circulation. Precipitation with neutral pH absorbs part of the CO<sub>2</sub> of the air so it becomes slightly acid. After that, any water that filtrates into the soil and surface water absorb up to a certain extent the elements that create the soil. Among these salts, you can mostly find Calcium, Magnesium and in a lesser amount there is iron, manganese and a lot of other elements. Building up of lime scale is a process while salts dissolved in water get separated so on the inner walls of heat emitter and heating devices there is a deposit of lime scale, which causes congestions, reduced heat emission, lower efficiency and often definitive damages. At increasing temperatures, the process can get even faster, so the following devices have a higher risk of having a limescale deposit: boilers, parts and pipes of central heating and hot water supplying systems, washing machines and dishwashers, steam irons, etc.

## **THE WATER SOFTENER STOPS THE DEPOSIT OF LIMESCALE**

Ion exchanging water softening procedure thrives on the fact that the device changes the calcium and magnesium ions of the salts dissolved in water into natrium ions. Natrium salts do not cause limescale deposits even when there is heat.

## 2. TECHNICAL PARAMETERS OF THE DEVICE

<b>Min. pressure</b>	<b>: 2,5bar</b>
<b>Max. pressure</b>	<b>: 6bar</b>
<b>Min. temperature</b>	<b>: 4C°</b>
<b>Max. temperature</b>	<b>: 25C°</b>
<b>Hardness</b>	<b>: under 0,1 nk</b>
<b>Content of salt</b>	<b>: invariable</b>
<b>pH value</b>	<b>: invariable</b>
<b>Regenerating chemical</b>	<b>: high purity NaCl tablet</b>
<b>Quantity</b>	<b>: 0,1 - 0,24 kg/ litres of resin per column/reg.</b>
<b>Connection to electricity</b>	<b>: 230 V, 50 Hz</b>

### **The quality of the water to be treated needs to be near drinking water quality.**

Max. iron and manganese content	: 0.1 mg/l
Max. consumption of potassium-permanganate	: 10 mg/l
Max. content of floating material	: 2 mg/l

# Euro-Clear Ltd.

Water purification and treatment equipment manufacturer and wholesale distributor

Tel: +36 96 544-240 • E-mail: [contact@euro-clear.eu](mailto:contact@euro-clear.eu) • Web: [www.euro-clear.eu](http://www.euro-clear.eu)

Detailed technical parameters of parallel connected volume-controlled twin two-three water softener equipments:

Part number	Resin vol./cap. liter/m <sup>3</sup> x°dH	Control valve / Connection	Brine volume (liter)	Flow m <sup>3</sup> /h	Top Flow m <sup>3</sup> /h	Salt cons. kg/reg.	Size (mm) H x W x L	Weight kg
BlueSoft 40D1/65	2x10 / 2x60	RX-65C-DVS 1"	2 x 25	0.8-2.0	2.2 - 3.0	1.0—2.4	890 x 740 x 640	50
BlueSoft 60D1/65	2x15 / 2x60	RX-65C-DVS 1"	2 x 70	1.2-2.4	2.2 - 3.0	1.5—3.6	1080 x 740 x 560	58
BlueSoft 120D1/65	2x30 / 2x120	RX-65C-DVS 1"	2 x 70	2.2-3.0	2.2 - 3.0	3.0—7.2	1080 x 740 x 640	120
BlueSoft 180D1/63	2x45 / 2x180	RX-63C-DVS 5/4"	2 x 70	2.5-4.5	6.2 - 8.4	5.5—10.8	1600 x 840 x 640	160
BlueSoft 240D1/63	2x60 / 2x240	RX-63C-DVS 5/4"	2 x 145	3.5-6.3	6.2 - 8.4	6—14.4	1450 x 1040 x 690	180
BlueSoft 320D1/63	2x80 / 2x320	RX-63C-DVS 6/4"	2 x 145	4.0-7.2	6.2 - 8.4	8—19.2	1610 x 1200 x 900	230
BlueSoft 400D1/63	2x100 / 2x400	RX-63C-DVS 6/4"	2 x 200	5.0-8.4	6.2 - 8.4	10—24	1890 x 1240 x 920	300
BlueSoft 400D1/92	2x100 / 2x400	RX-92A-DVS 6/4"	2 x 200	5.0-9.0	9.5 - 13.0	10—24	1890 x 1240x 920	300
BlueSoft 500D1/63	2x125 / 2x500	RX-63C-DVS 6/4"	2 x 200	6.5-8.4	6.2 - 8.4	12.5—30	1930 x 1330x 970	360
BlueSoft 500D1/92	2x125 / 2x500	RX-92A-DVS 6/4"	2 x 200	6.5-11.7	9.5 - 13.0	12.5—30	1930 x 1330 x 970	360
BlueSoft 500D1/74	2x125 / 2x500	RX-74A-DVS 2"	2 x 200	6.5-11.7	13.0 - 17.6	12.5—30	1930 x 1330 x 970	390
BlueSoft 600D1/74	2x150 / 2x600	RX-74A-DVS 2"	2 x 350	9.0-16.2	13.0 - 17.6	15—36	1980 x 1490 x 1240	470
BlueSoft 800D1/74	2x200 / 2x800	RX-74A-DVS 2"	2 x 500	11.0-17.6	13.0 - 17.6	20—48	1890 x 1680 x 1400	650
BlueSoft 1200D1/74	2x300 / 2x1200	RX-74A-DVS 2"	2 x 750	13.0-17.6	13.0 - 17.6	30—72	2170 x 1920 x 1580	940
BlueSoft 1200D1/99	2x300 / 2x1200	RX-99A-DVS 3"	2 x 750	14.0-25.2	28.8 - 37.6	30—72	2170 x 1920 x 1580	940
BlueSoft 1600D1/99	2x400 / 2x1600	RX-99A-DVS 3"	2 x 750	22.0-37.6	28.8 - 37.6	40—96	2490 x 2040 x 1730	1370
BlueSoft 1800D1/99	2x450 / 2x1800	RX-99A-DVS 3"	2 x 750	22.0-37.6	28.8 - 37.6	45—108	2490 x 2040 x 1730	1470
BlueSoft 2000D1/99	2x500 / 2x2000	RX-99A-DVS 3"	2 x 750	22.0-37.6	28.8 - 37.6	50—120	2490 x 2040 x 1730	1470

# Euro-Clear Ltd.

Water purification and treatment equipment manufacturer and wholesale distributor

Tel: +36 96 544-240 • E-mail: [contact@euro-clear.eu](mailto:contact@euro-clear.eu) • Web: [www.euro-clear.eu](http://www.euro-clear.eu)

Part number	Resin vol./cap. liter/m <sup>3</sup> x°dH	Control valve / Connection	Brine volume (liter)	Flow m <sup>3</sup> /h	Top Flow m <sup>3</sup> /h	Salt cons. kg/reg.	Size (mm) H x W x L	Weight kg
BlueSoft 2400D1/99	2x600 / 2x2400	RX-99A-DVS 3"	2 x 1000	32.0-37.6	28.8 - 37.6	60—144	2500 x 2370 x 2020	1950
BlueSoft 2800D1/99	2x700 / 2x2800	RX-99A-DVS 3"	2 x 1000	32.0-37.6	28.8 - 37.6	70—168	2450 x 2870 x 2020	2140
BlueSoft 2800D1/112	2x700 / 2x2800	RX-112S-DVS DN100	2 x 1000	32.0-57.6	73.8 - 95.0	70—168	2600 x 2500 x 3600	2210
BlueSoft 3200D1/112	2x800 / 2x3200	RX-112SM-DVS DN125	2 x 1500	44.0-79.2	73.8 - 95.0	80—192	2600 x 2500 x 3600	2850
BlueSoft 3600D1/112	2x900 / 2x3600	RX-112SM-DVS DN125	2 x 1500	44.0-79.2	73.8 - 95.0	90—216	2600 x 2500 x 3600	3040
BlueSoft 4000D1/112	2x1000/2x4000	RX-112SM-DVS DN125	2 x 1500	44.0-79.2	73.8 - 95.0	100—240	2600 x 2500 x 3600	3240
BlueSoft 4400D1/112	2x1100 / 2x4400	RX-112SM-DVS DN125	2 x 2000	56.0-95.0	73.8 - 95.0	110—264	2800 x 2700 x 3700	3880
BlueSoft 4800D1/112	2x1200 / 2x4800	RX-112SM-DVS DN125	2 x 2000	56.0-95.0	73.8 - 95.0	120—288	2800 x 2700 x 3700	4080
BlueSoft 5600D1/112	2x1400 / 2x5600	RX-112SM-DVS DN125	2 x 2000	73.8-95.0	73.8 - 95.0	140—336	2900 x 3500 x 4500	5860
BlueSoft 5600D1/96	2x1400 / 2x5600	RX-96SM-DVS DN150	2 x 2000	100-121	91.4 - 121	140—336	2900 x 3500 x 4500	5860
BlueSoft 6400D1/96	2x1600 / 2x6400	RX-96SM-DVS DN150	2 x 3000	100-121	91.4 - 121	160—384	2900 x 3500 x 4500	6250
BlueSoft 7200D1/96	2x1800 / 2x7200	RX-96SM-DVS DN150	2 x 3000	100-121	91.4 - 121	180—432	2900 x 3500 x 4500	6640
BlueSoft 8000D1/96	2x2000 / 2x8000	RX-96SM-DVS DN150	2 x 3000	100-121	91.4 - 121	200—480	2900 x 3500 x 4500	7030

The advantage of the parallel connected volume-controlled twin water softener equipments is that both column have separate control valve, so this way it is able to operate with twice the nominal power. The two control valve are connected with one communication cable. The two control valve are watching each other's operating state. At the same time, only one control head is able to regenerate, this ensures the equipment's continuous soft water supply. The main area of use of the twin water softener equipments: hotels, condominiums, opened-closed cooling circuits, pool's substitute water supply but it is suggested to use for higher water demand. **In the future the twin two columned water softener equipment will be expandable anytime with connecting three or more column through a communication cable.**

*These pictures are illustrations, it shows the D1 water softener equipment's structural design and collimation. The brine tanks can be placed in next to the pressure tanks.*

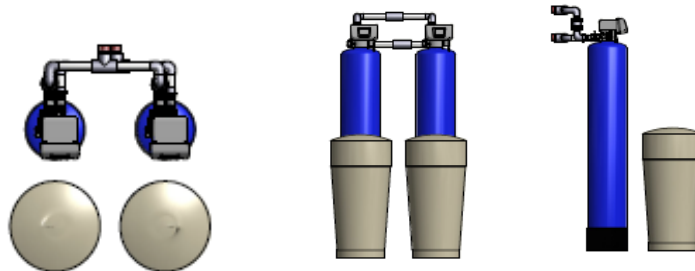

# Euro-Clear Ltd.

Water purification and treatment equipment manufacturer and wholesale distributor

Tel: +36 96 544-240 • E-mail: [contact@euro-clear.eu](mailto:contact@euro-clear.eu) • Web: [www.euro-clear.eu](http://www.euro-clear.eu)

Detailed technical parameters of the parallel connected volume-controlled three columned water softener equipments:

Part number	Resin vol./cap. liter/m <sup>3</sup> x°dH	Control valve / Connection	Brine volume (liter)	Flow m <sup>3</sup> /h	Top Flow m <sup>3</sup> /h	Salt cons. kg/reg.	Size(mm) H x W x L	Weight kg
BlueSoft 180T1/63	3x45 / 3x180	RX-63C-DVS 6/4"	3 x 70	3.7-6.7	9.3 - 12.6	5.5—10.8	1700 x 1500 x 700	230
BlueSoft 240T1/63	3x60 / 3x240	RX-63C-DVS 6/4"	3 x 145	5.2-9.4	9.3 - 12.6	6—14.4	1600 x 1800 x 900	270
BlueSoft 320T1/63	3x80 / 3x320	RX-63C-DVS 2"	3 x 145	6.0-10.8	9.3 - 12.6	8—19.2	1800 x 1800 x 1000	340
BlueSoft 400T1/63	3x100 / 3x400	RX-63C-DVS 2"	3 x 200	7.5-12.6	9.3 - 12.6	10—24	2100 x 2100 x 1100	450
BlueSoft 400T1/92	3x100 / 3x400	RX-92A-DVS 2"	3 x 200	7.5-13.5	14.2 - 19.5	10—24	2100 x 2100 x 1100	450
BlueSoft 500T1/63	3x125 / 3x500	RX-63C-DVS 2"	3 x 200	9.7-12.6	9.3 - 12.6	12.5—30	2150 x 2100 x 1200	540
BlueSoft 500T1/92	3x125 / 3x500	RX-92A-DVS 2"	3 x 200	9.7-17.5	14.2 - 19.5	12.5—30	2150 x 2100 x 1200	550
BlueSoft 500T1/74	3x125 / 3x500	RX-74A-DVS 2"	3 x 200	9.7-17.5	19.5 - 26.4	12.5—30	2150 x 2100 x 1200	580
BlueSoft 600T1/74	3x150 / 3x600	RX-74A-DVS 2"	3 x 350	13.5-24.3	19.5 - 26.4	15—36	2250 x 2500 x 1400	710
BlueSoft 800T1/74	3x200 / 3x800	RX-74A-DVS 2"	3 x 500	16.5-26.4	19.5 - 26.4	20—48	2350 x 2800 x 1550	980
BlueSoft 1200T1/74	3x300 / 3x1200	RX-74A-DVS 2"	3 x 750	19.5-26.4	19.5 - 26.4	30—72	2450 x 3200 x 1700	1410
BlueSoft 1200T1/99	3x300 / 3x1200	RX-99A-DVS 3"	3 x 750	21.0-37.8	43.2 - 56.4	30—72	2450 x 3200 x 1700	1420
BlueSoft 1600T1/99	3x400 / 3x1600	RX-99A-DVS 3"	3 x 750	33.0-56.4	43.2 - 56.4	40—96	2450 x 3200 x 1900	2050
BlueSoft 1800T1/99	3x450 / 3x1800	RX-99A-DVS 3"	3 x 750	33.0-56.4	43.2 - 56.4	45—108	2450 x 3200 x 1900	2200
BlueSoft 2000T1/99	3x500 / 3x2000	RX-99A-DVS 3"	3 x 750	33.0-56.4	43.2 - 56.4	50—120	2450 x 3200 x 1900	2350

# Euro-Clear Ltd.

Water purification and treatment equipment manufacturer and wholesale distributor

Tel: +36 96 544-240 • E-mail: [contact@euro-clear.eu](mailto:contact@euro-clear.eu) • Web: [www.euro-clear.eu](http://www.euro-clear.eu)

Part number	Resin vol./cap. liter/m <sup>3</sup> x <sup>o</sup> dH	Control valve / Connection	Brine volume (liter)	Flow m <sup>3</sup> /h	Top Flow m <sup>3</sup> /h	Salt cons. kg/reg.	Size(mm) H x W x L	Weight kg
BlueSoft 2400T1/99	3x600 / 3x2400	RX-99A-DVS 3"	3 x 1000	48.0-56.4	43.2 - 56.4	60—144	2500 x 3800 x 2200	2930
BlueSoft 2800T1/99	3x700 / 3x2800	RX-99A-DVS 3"	3 x 1000	48.0-56.4	43.2 - 56.4	70—168	2500 x 3800 x 2200	3220
BlueSoft 2800T1/112	3x700 / 3x2800	RX-112SM-DVS DN100	3 x 1000	48.0-86.4	110 - 142	70—168	2550 x 3800 x 2400	3340
BlueSoft 3200T1/112	3x800 / 3x3200	RX-112SM-DVS DN100	3 x 1500	66.0-118	110 - 142	80—192	2700 x 4000 x 3500	4220
BlueSoft 3600T1/112	3x900 / 3x3600	RX-112SM-DVS DN100	3 x 1500	66.0-118	110 - 142	90—216	2700 x 4000 x 3500	4420
BlueSoft 4000T1/112	3x1000 / 3x4000	RX-112SM-DVS DN100	3 x 1500	66.0-118	110 - 142	100—240	2700 x 4000 x 3500	4800
BlueSoft 4400T1/112	3x1100 / 3x4400	RX-112SM-DVS DN125	3 x 2000	84.0-142	110 - 142	110—264	2700 x 5400 x 4300	5770
BlueSoft 4800T1/112	3x1200 / 3x4800	RX-112SM-DVS DN125	3 x 2000	84.0-142	110 - 142	120—288	2700 x 5400 x 4300	6060
BlueSoft 5600T1/112	3x1400 / 3x5600	RX-112SM-DVS DN125	3 x 2000	110-142	110 - 142	140—336	2800 x 5400 x 4600	8740
BlueSoft 5600T1/96	3x1400 / 3x5600	RX-96SM-DVS DN150	3 x 2000	150-181	137 - 181	140—336	2800 x 5400 x 4600	8740
BlueSoft 6400T1/96	3x1600 / 3x6400	RX-96SM-DVS DN150	3 x 3000	150-181	137 - 181	160—384	2800 x 8500 x 4600	9320
BlueSoft 7200T1/96	3x1800 / 3x7200	RX-96SM-DVS DN150	3 x 3000	150-181	137 - 181	180—432	2800 x 8500 x 4600	9910
BlueSoft 8000T1/96	3x2000 / 3x8000	RX-96SM-DVS DN150	3 x 3000	150-181	137 - 181	200—480	2800 x 8500 x 4600	10500

The advantage of the parallel connected triplex three columned water softener equipment is that all three column has a separate control valve, this way it is able to operate with three times the nominal power. The three control valve are connected with two communication cable. The three control valve are watching each other's operating state. At the same time only one control head is able to regenerate, this ensure the equipment's continuous soft water supply. The main area of use of the triplex water softener equipments: hotels, condominiums, opened-closed cooling circuits, pool's substitute water supply but it is suggested to use anywhere else where the need for higher capacity of the equipment's dimensioned water demand rises.

**In the future the twin two columned water softener equipment will be expandable anytime with connecting four or more column through a communication cable. This way the power of the equipment can be further increased.**

# Euro-Clear Ltd.

Water purification and treatment equipment manufacturer and wholesale distributor  
Tel: +36 96 544-240 • E-mail: [contact@euro-clear.eu](mailto:contact@euro-clear.eu) • Web: [www.euro-clear.eu](http://www.euro-clear.eu)

## 3. . MAIN PARTS

Basically, the device consists of the following main parts.

### 3.1. Columns to keep resin

They are meant to store the resin charge. The columns are PE pressure tanks developed especially for treating water with polyethylene padding. Outside they have epoxy resin coat rolled by fibre.

Their features are that they last long, have little weight and resist to chemicals and corrosion.

### 3.2. Resin to exchange ion

Its function is to complete ion exchanging processes on the resin bed. Ion exchanging processes are the base of the chemical operation of the device.

### 3.3. Blocked valve to regenerate

Its task is to ensure that the mechanical work processes of the device are completed in a programmed, regulated way.

### 3.4. Brine tank

Its task is to produce the brine solution necessary for the regeneration and to store the regeneration salt.

## 4. HOW IT WORKS

### 4.1. CHEMICAL OPERATION

The chemical operation of the device thrives on the fact that the resin that gets filled in is an ion exchanging resin. The resin has this property thanks to the active groups that have free valence and are planted in the neutral polystyrene substrate. The affinity of this compound is relatively small to the sodium and big to the calcium and magnesium. During the operation, the resin that exchanges ion and is loaded with sodium keeps changing the calcium and magnesium ions of the water into sodium ion. This process itself is meant to be the water softening, and it carries on as long as there is sodium on the active groups of the resin.

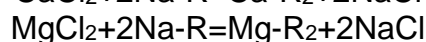
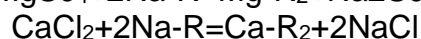
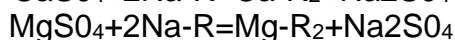
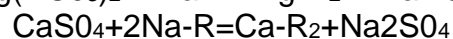
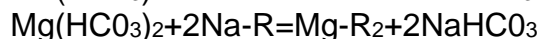
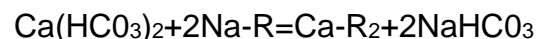



# Euro-Clear Ltd.

Water purification and treatment equipment manufacturer and wholesale distributor  
Tel: +36 96 544-240 • E-mail: [contact@euro-clear.eu](mailto:contact@euro-clear.eu) • Web: [www.euro-clear.eu](http://www.euro-clear.eu)

If the ion exchanging resin gets saturated with calcium and magnesium ions during the operation, the resin is considered discharged.

The discharged resin needs to be regenerated. During regeneration, calcium and magnesium ions get removed from the active groups of the resin and we plant natrium ions to their place. Due to the different affinity, this process can happen only if there is a significant surplusage of natrium. In practice, we get a 10 % NaCl solution to flow through the resin during regeneration. The natrium from the solution gets connected to the active groups of the resin, and the removed calcium and magnesium get connected to the chloride ion and get into the channel together with the regeneratum.

Apart from the calcium and magnesium, there are several other elements in the water. In case the content of iron and manganese is high, the resin to exchange ion can get damaged partly reversibly, partly irreversibly. The harmful deposit on the resin can be removed by etchant, but, for a safe operation, only drinking water quality water is allowed for operating the device. **Where the quality of the water is worse, pre-filtering must be completed and iron must be removed.**

## 4.2. MECHANICAL OPERATION

While the device is operating, the mechanical operation of the blocked valve provides the automatical fulfillment of the processes of water production and regeneration.

### 4.2.1. WATER PRODUCTION

During water production, the water enters the column to keep resin through the upper filter, and it flows through the ion exchanging resin from up to down. The softened water leaves the device through the lower filter.

### 4.2.2. PRE-WASH

During pre-wash, the way of the water is the same as the water production's way, but the water leaves the device through the drain.

### 4.2.3. BACKWASH

During backwash, the water enters the column to keep resin through the lower filter and it flows through the ion exchanging resin from down to up while the resin's charge gets stirred up. The water of backwash gets out into the channel through the drain.

### 4.2.4. BRINE UPTAKE (regeneration)

As it gets through the water jet pump built into the blocked valve (injector), the water uptakes saturated brine from the brine tank and dilutes it up to about of 10 per cent.

# Euro-Clear Ltd.

Water purification and treatment equipment manufacturer and wholesale distributor  
Tel: +36 96 544-240 • E-mail: [contact@euro-clear.eu](mailto:contact@euro-clear.eu) • Web: [www.euro-clear.eu](http://www.euro-clear.eu)

This solution enters the column to keep resin through the upper filter, and it flows through the resin charge from up to down. While the solution is flowing through, the resin charge gets regenerated. The sewage water of the regeneration leaves through the lower filter at the drain into the channel.

## 4.2.5. SLOW WASH

The slow wash is a process that has the same direction as the brine uptake. Slow wash starts when the brine tank runs out of salt solution. Then the salt valve fixed into the brine tank closes and stops the sipping effect from sipping air into the column to keep resin. During slow wash, the salt solution gets removed from the resin charge.

## 4.2.6. QUICK WASH

During quick wash, the water enters the column to keep resin through the lower filter, and it flows through the resin charge from down to up. It leaves through the upper filter at the drain into the channel. During quick wash, the traces of the regenerating chemical get removed and the right water quality gets set up.

## 4.2.7. DOWNFLOW WASHING

The water enters the column to keep resin through the upper filter and flows through the resin charge from up to down. It leaves through the lower filter at the drain into the channel. During the downflow washing the resin charge that has been stirred up during the quick wash gets recompressed.

## 4.2.8. FILLING UP THE BRINE TANK

The water enters the column to keep resin through the upper filter. It flows through the resin charge from up to down. It gets into the brine tank through the lower filter then through the pipe which soaks the salt up. Filling back is time controlled. The water for filling up makes a saturated salt solution with the salt tablet in the brine tank and it is used up during the next regeneration.

## 4.3. DETAILED DESCRIPTION OF THE WAY THE CONTROL WORKS

The automatic blocked valve completes all the operation processes (operation, regeneration) on the basis of the setting up of the clockwork engine. The automatic blocked valve gets the mechanics of the valves to work as well.

The build-up and setting up of the blocked valve are described in the annex.

## 5. INSTALLATION AND STARTUP

### 5.1. CONDITIONS OF INSTALLATION

A room with flat, horizontal and hard flooring is needed for the installation of the device. The flooring and the direct surroundings of the device must resist to the corrosive effect of the brine. The device must be installed in a room the temperature of which is between +5°C to +40°C. The temperature of the raw water to be treated must not exceed +30 °C. The device must not be installed in a strongly damp or dusty room. It must be protected from frost, radiant heat and ultraviolet radiance.

Near the device, sewage connection and 230 V 50 Hz grounded, electric socket must be provided. In order to diminish risks, we advise to install the device into a room provided with floor drainage.

Below water pressure of 2,5 bars, proper regeneration is not guaranteed, so in this case we advise to build in a device to increase pressure.

In case the water pressure from the water system exceeds 6 bars, a device to decrease pressure has to be fixed in front of the device.

Fluctuation of pressure higher than  $\pm 0,5$  bar is not allowed! Mechanical protective filter must be built in front of the device. It is important that the mechanical protective filter filters contamination bigger than 100 microns.

The device does not have any extra protection against water or electricity shortage. If needed, it must be provided while installing.

### 5.2. CONNECTION OF THE EQUIPMENT *(it is the responsibility of the customer)*

It is the customer's task to have the device connected to the water, sewage and electricity systems. The operator of the device and the specialist to complete the installation should both check if the device has been installed as described in the guide for use and handling and if the conditions to diminish risks of damage are given. The setting up of the device can be completed by the partner of the Euro-Clear Hungary Ltd's service that has a partnership contract. Setting up the device only means the setting up of the automatical control valve fulfilling the local conditions.

When setting up, the valid local regulations, general instructions and hygiene regulations must be followed and the technical parameters given above must be respected.

# Euro-Clear Ltd.

Water purification and treatment equipment manufacturer and wholesale distributor

Tel: +36 96 544-240 • E-mail: [contact@euro-clear.eu](mailto:contact@euro-clear.eu) • Web: [www.euro-clear.eu](http://www.euro-clear.eu)

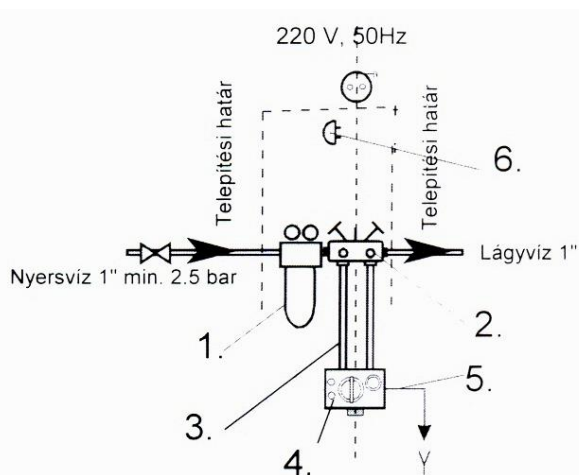

1. Pre-filtering equipment
2. Montageblock or build by-pass branch
3. Flexible tube pair
4. Control valve of the water softening equipment
5. Drain
6. Electrical outlet
7. Gravitation drainage on the floor

The pre-filtering device No. 1 and the montageblock No. 2's usage is operational and warranty condition. The montageblock can be replaced by a by-pass branch built from 3 valves. When building in this unit into the pipe, make sure that you connect the raw water onto the filter „1” and the softened water that comes out has to be connected onto the montageblock „2”.

The water softener and the montageblock can be connected by the flexible tube pair No. 3. When connecting, pay attention to the flow direction of the water which is marked by the arrows at the montageblock No. 2 and the control valve No 4.

There is a hose outlet on the control valve No. 4, which is the drain of the device. The water that comes out has to be led into the drain canal. This job can be completed by the plastic hose No. 5. The hose must be pressure resistant as a simple garden hose breaks after a while and the narrow diameter can stop the completion of the regeneration. The drain water comes out of the device under pressure, but it must be led by free outlet.

An electric plug underlaid of 230 V, 50 Hz must be built within a distance from the equipment that allows the completion of the connection of the prong plug number 6 without the electric cable's getting tight.

During backwash, water comes out from the pre-filtering device No. 1. It is advised to connect the sewage connection snag into the drain. In this case the drain water will come out under pressure, too.

On the side of the regenerating tank of the water softening device there is an overflow snag which the superfluous water can get through in case of a breakdown. The liquid has got a hydrostatic pressure, so it can be led only by using floor drainage or a siphon drainage fixed at a low level.

An overflowing snag can be found on the water softener equipment's regenerating tank's side, on which in case of malfunction the unnecessary water can leave. The safety overflow snag of the tank can be led to the drain point by a 1/2" pressure

# Euro-Clear Ltd.

Water purification and treatment equipment manufacturer and wholesale distributor  
Tel: +36 96 544-240 • E-mail: [contact@euro-clear.eu](mailto:contact@euro-clear.eu) • Web: [www.euro-clear.eu](http://www.euro-clear.eu)

resistant plastic tube. The water that eventually comes out does not have any pressure, so it must be led to the drain or into the raiser by a slope.

The drain of operation of the water softening device and the overflow of the brine tank can be connected to the sewage leading points respecting the following rules.

- Respecting DIN 1988, the tube of the rinsing water and the overflow tube must be fixed at the sewage water connection point, at least at a distance of 20 mm compared to the highest sewage water level, so that the water can get out of the device smoothly.



- The high pressure rinsing water that comes out of the control valve (4) during regeneration must not get to the brine tank through the overflow tube. Make sure that the sewage waterpipe of the water softener and the overflow pipe of the brine are each connected separately into the sewage water.

## 5.3. SETTING UP OF THE EQUIPMENT

After the jobs mentioned in point 5.2 have been completed, you have to order the setting up of the machine from Euro-Clear Ltd at one of the contact details below:

Mailing address: 9071 Gönyű, Béke u. 2.

E-mail address: [contact@euro-clear.eu](mailto:contact@euro-clear.eu)

Web address: [www.euro-clear.eu](http://www.euro-clear.eu)

After the device has been set up, the copy of the warranty document filled in by the person having completed the setting up has to be sent to the address above in a verifiable way.

The fee of the setting up jobs gets calculated on the basis of the actual price list.

## 6. INSTRUCTION ABOUT HANDLING

1./ Check daily the

- hardness of the incoming water and the
  - hardness of the softened water,
- they must be noted in the operation diary.

# Euro-Clear Ltd.

Water purification and treatment equipment manufacturer and wholesale distributor  
Tel: +36 96 544-240 • E-mail: [contact@euro-clear.eu](mailto:contact@euro-clear.eu) • Web: [www.euro-clear.eu](http://www.euro-clear.eu)

## 2./ Check daily

- the quantity of the regenerating salt in the brine tank, fill it up if necessary, note it in the operation diary.

3./ In the brine tank, there must always be an undissolved solid salt tablet enough for one regeneration.

4./ Make sure you keep checking the brine consumption as this is the way you can find out if the device regenerates automatically.

5./ You need to check daily the pressure of the incoming water on the pressure gauge. In case it decreases by more than 0,5 bars, clean the pre-filter.

6./ Remove dust from the device with a dry cloth every two weeks.

7./ The pre-filtering device must be rinsed back depending on the extent of the contamination but at least once a week. It must be done with the sewage water drain tap that you can find on the bottom of the device. Rinsing back must last for at least 15-20 seconds.

8./ Clean the brine tank once a month.

9./ Make sure that the device keeps getting 230 V, 50 Hz electricity all the time, for 24 hours and it is under system pressure continuously.

## 7. Process of measuring the water hardness

The kit that measures water hardness contains a measuring cup and a plastic vial containing some titrating liquid. You can find the same liquid in both of the vials.

- Before testing, the measuring cup needs to be rinsed and then filled up with the water sample to be tested up to the mark of 5 ml. Add a drop of titrating liquid to the water sample in the cup, and then shake the 2 liquids gently.

- If the first drop of titrating liquid makes the water greenish, the tested water is soft water.

If it is not the case, keep repeating the operation until the red colour of the mixture gets greenish. Each drop of the titrating liquid is the equivalent of 1 German hardness, so the hardness of the tested water sample is the same as the number of the drops which are added as long as the sample has got greenish.

- By filling the cup up to the level of 10 ml, you can measure by 0,5 grades if you follow the method mentioned above. In this case, 1 drop of titrating liquid will be the equivalent of 0,5 nk.

# Euro-Clear Ltd.

Water purification and treatment equipment manufacturer and wholesale distributor

Tel: +36 96 544-240 • E-mail: [contact@euro-clear.eu](mailto:contact@euro-clear.eu) • Web: [www.euro-clear.eu](http://www.euro-clear.eu)

## 8. WARRANTY, GUARANTEE

In case of non-performance by the producer, the owner of the device can benefit from all warranty rights in 306-309. § in the Civil Code.

The owner of the device can claim for warranty and guarantee only by showing both the receipt that has been received when buying the device and that proves the payment of the complete price and the warranty document that has been filled in.

Warranty and guarantee do not cover faults that have been caused by the following:

- The product has not been used properly, the instructions of the way of handling, using, installing or maintaining etc. have not been respected
- The operation diary has not been kept
- the necessary corrective maintenance has not been completed, or has not been done by the designated professional servicing company,
- the product's nature has been transformed, changed
- the owner of the device has not completed their liability of reducing risks of damage
- Defects, damages and other problems caused by improper transportation and storage of the product.

Warranty and guarantee claims can be validated only in case the operator of the device sends to the producer both pages of the operation data sheet filled in and signed by the professional mechanic in charge of setting up of the device. It must be sent in a provable way.

Please send back to the address below both pages of the data sheet of setting up that have been filled in and signed:

Euro-Clear Ltd.

Mailing address: 9071 Gönyű, Béke u. 2.

E-mail: [contact@euro-clear.eu](mailto:contact@euro-clear.eu)

# Euro-Clear Ltd.

Water purification and treatment equipment manufacturer and wholesale distributor  
Tel: +36 96 544-240 • E-mail: [contact@euro-clear.eu](mailto:contact@euro-clear.eu) • Web: [www.euro-clear.eu](http://www.euro-clear.eu)

## INSTALLATION DATA SHEET

Name of specialist to complete setting up: .....

Contact details of the specialist completing the setting up

- Mailing address: .....
- Telephone number: .....
- E-mail address: .....

Name of the company selling the device: .....

Contact details of the company selling the device

- Mailing address: .....
- Telephone number: .....
- E-mail address: .....

Name of the operator of the device: .....

Contact details of the operator of the device

- Mailing address: .....
- Telephone number: .....
- E-mail address: .....

Type of the set up device: BlueSoft .....

Date of setting up: .....

.....  
**signature, stamp**

**Warranty and guarantee are only valid in case the setting up has been completed by Euro-Clear Ltd or its agent. You can order the setting up of the device at the contact details mentioned below.**

Euro-Clear Ltd.  
9071 Gönyű, Béke u. 2.  
Tel: +3696/544-240  
[contact@euro-clear.eu](mailto:contact@euro-clear.eu)



# Euro-Clear Ltd.

Water purification and treatment equipment manufacturer and wholesale distributor

Tel: +36 96 544-240 • E-mail: [contact@euro-clear.eu](mailto:contact@euro-clear.eu) • Web: [www.euro-clear.eu](http://www.euro-clear.eu)

## Data sheet for setting up

- Igen
1. Check the mechanical and electricity connections as follows:
    - 1.1. Is a mechanical protection filter built in front of the water softener?
    - 1.2. Is the pressure of the raw water convenient? (2,5 – 6 bar)
    - 1.3. Are the directions of water flow convenient? (on the montage block, on the device)
    - 1.4. Are the outlet of the softening rinsing water and the gravitation overflow of the brine tank connected separately onto the channel?
    - 1.5. Is the electricity input right? (230V, 50HZ)
- Before you connect the control valve to electrical network, close the incoming water's connection, after the setting the values and before starting the manual regenerating, open the incoming water's tap.**
- 1.6. Has the hardness of the raw water been measured?   
If yes, then the measured value is: .....nk<sup>0</sup>
  2. Program the control head of the water softening device
    - 2.1. Have the exact date and time been set?
    - 2.2. Setting the time for regeneration or the quantity 
      - 2.2.1. In case the device is time controlled, has the time between the two regenerations been set up (in m3)?   
If yes, then the value is: ..... day
      - 2.2.2. In case the device is volume controlled, has the water quantity been set (in m<sup>3</sup>) for between the two regenerations?   
If yes, it has been set up to: ..... m<sup>3</sup>  
For example.: in case of a device type BlueSoft 70 and raw water of 20 German hardness, it must be set up to:  $70 / 20 = 3,5 \text{ m}^3$
    - 2.3. Filling back water into the brine tank  
Start a manual regeneration with button. Go ahead through the cycles backwash, brine draw up to the water refill cycle. Time for water refill cycle to be set up so there is a convenient quantity of water in the cabinet. Quantity of refilled water= resin literX0,8 (liter)  
Is the amount of water refilled adequate?
    - 2.4. Setting up time for washing (advanced settings)
      - 2.4.1. Has the time for backwash been set up? (Backwash)
      - 2.4.2. Has the time for brine draw (Brine Draw) been set up?
      - 2.4.3. Has the time for rinsing been set up? (Rinse)
      - 2.4.4. Is the time for water refill convenient? (Refill)
      - 2.4.5. Choice of regeneration mode (Regeneration Mode) :
        - time (Timer)
        - immediate volume controlled regeneration (Meter immediately)
        - volume controlled delayed regeneration (Meter delayed)
  3. Starting manual regeneration, checking function cycles:
    - 3.1. Backwash (water gets onto the channel intensively).  
Is everything all right with the function cycle?
    - 3.2. Brine absorption (little water comes out into the channel, the cabinet is running out of brine).  
Is everything all right with the function cycle?
    - 3.3. Water refill into the cabinet. Is everything all right with the function cycle?
    - 3.4. Backwash (onto a channel of higher volume of water flow)
  4. After finishing regeneration, check the hardness of the water coming down from the device.  
Without back mix, is the hardness of the water made by the device lower than 1 gh?
  - 5 Set the water hardness up to at least 5 Gh in compliance with the regulation of the government 5/2023. (The device can make water of lower hardness, too.) Possibilities of setting up hardness: On the montage block or helped with by-pass valve on the control head.  
Water hardness that has been set up: .....nk<sup>0</sup>
  6. Filling up the brine tank with tablets of salt. (Recommended quantity is at least the necessary daily salt.)
  7. Train the staff who are handling the equipment.
  8. Filling the warranty document.

# Euro-Clear Ltd.

Water purification and treatment equipment manufacturer and wholesale distributor  
Tel: +36 96 544-240 • E-mail: [contact@euro-clear.eu](mailto:contact@euro-clear.eu) • Web: [www.euro-clear.eu](http://www.euro-clear.eu)

## WARRANTY DOCUMENT

In case the device is properly used, the producer undertakes a warranty of **12 months** starting from the setting up, but maximum **18 months** starting from the date of issuing the quality certificate.

**DATE OF SETTING UP:**

.....

.....

**signature, stamp**

The warranty and guarantee are only valid in case the setting up has been completed by Euro-Clear Ltd. or its agent. You can order the setting up of the device at the details mentioned below.

Please send us back the warranty document, setting up data sheet completely filled. In other case the warranty is not valid.

Please keep the warranty document, setting up data sheet and quality certificate for administration purposes in the future.

In case of a breakdown or fault, please inform us in written at the e-mail address [contact@euro-clear.eu](mailto:contact@euro-clear.eu) about the problem that has occurred.

